

THE INFORMATION CONTAINED IN THIS DOCUMENT IS PROPRIETARY TO Y-S ELECTRONIC, ANY REPRODUCTION IN PART OR WHOLE WITHOUT PRIOR WRITTEN APPROVAL OR AUTHORIZATION OF Y-S ELECTRONIC IS STRICTLY PROHIBITED.

RoHS COMPLIANT

REV.	DESCRIPTION	ECN NO.	DWN.	CHK.	APVD.	DATE
A			Xie	Fan	Zhou	2017.12.15

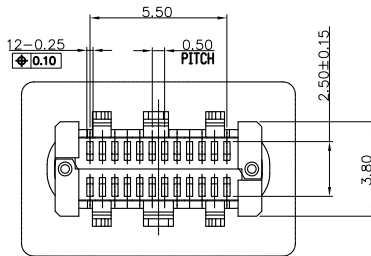
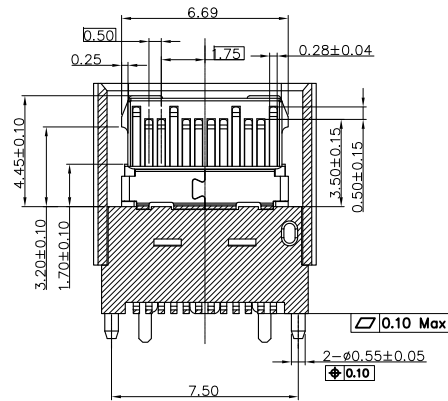
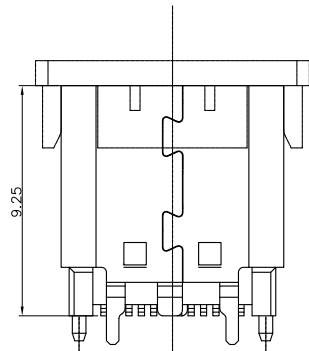
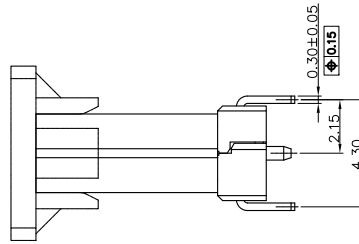
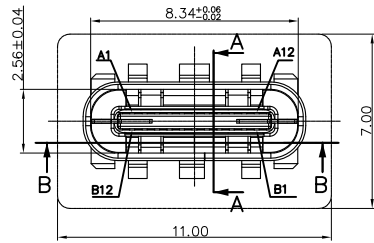
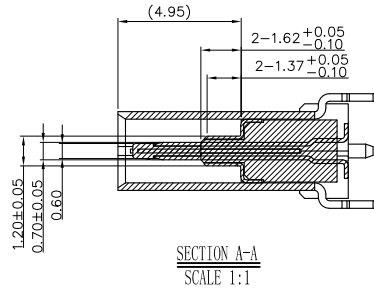
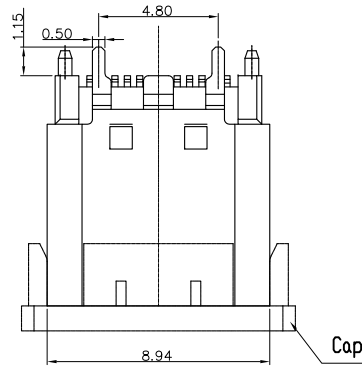

- NOTES: 1.MATERIAL:
MOLDING: LCP UL94 V-0
CONTACT: COPPER ALLOY.
GOLD PLATED Min ON CONTACT AREA,100u"
Min TIN (LEAD FREE) ON SOLDER AREA,
SHELL: SUS304-H,T=0.30±0.03mm
50u" NICKEL PLATING OVER ALL.
SHILD: SUS304-H,T=0.12±0.03mm
- 2.MECHANICAL:
INSERTION: 5~20N.
EXTRACTION: 8~20N AFTER TEST.
DURABILITY: 10000 CYCLES
- 3.ELECTRICAL:
CURRENT: 5A FOR VBUS;
1.25A FOR GND PIN.
0.25A FOR OTHER.
VOLTAGE: 20 V MAX
WITHSTANDING VOLTAGE: 100V AC R.M.S.
CONTACT RESISTANCE: 40mΩ MAX.
INSULATION RESISTANCE: 100MΩ MIN.
- 4.ENVIRONMENTAL
TEMPERATURE RANGE -25°C ~ +85°C

Ordering Information

184j - $\frac{XX}{a} \frac{X}{b} \frac{X}{c} \frac{X}{d} \frac{X}{e} \frac{X}{f}$

- a. No. Of Pins
24: 24 positions
- b. Contact Type
4: Female (Four feet DIP TYPE)
- c. Contact Plating
0: Gold flash selective gold
1: 5u" selective gold over 50u" nickel
2: 15u" selective gold over 50u" nickel
3: 30u" selective gold over 50u" nickel
4: 10u" selective gold over 50u" nickel
- d. Shell Type
1: Nickel
- e. Insulator Color
1: Black (LCP)
- f.Contact Type(Signal Pin)
8: 180° SMT Type(H=9.3mm)

DO NOT SCALE DRAWING

DIMENSIONS: <input type="checkbox"/> mm [INCH] <input type="checkbox"/> INCH [mm] <input checked="" type="checkbox"/> mm ONLY		CAD GENERATED DRAWING, DO NOT MANUALLY UPDATE			
UNLESS OTHERWISE SPECIFIED, GENERAL TOLERANCE: DECIMALS ANGLES .X ±0.38 X° ±3° .X ±0.25 .X° ±1.0° .XX ±0.15		DRAWN BY AND DATE Xie 2017-12-15			
MATERIAL:		CHECKED BY AND DATE Fan 2017-12-15		DRAWING NO. 184j-2440118	
FINISH:		APPROVED BY AND DATE Zhou 2017-12-15		REV A	
THIRD ANGLE PROJECTION		SCALE: 1 : 1		FILE NO.:	
SIZE: A3		SHEET 1 OF 4			

THE INFORMATION CONTAINED IN THIS DOCUMENT IS PROPRIETARY TO Y-S ELECTRONIC, ANY REPRODUCTION IN PART OR WHOLE WITHOUT PRIOR WRITTEN APPROVAL OR AUTHORIZATION OF Y-S ELECTRONIC IS STRICTLY PROHIBITED.

RoHS COMPLIANT

REV.	DESCRIPTION	ECN NO.	DWN.	CHK.	APVD.	DATE
A			Xie	Fan	Zhou	2017.12.15

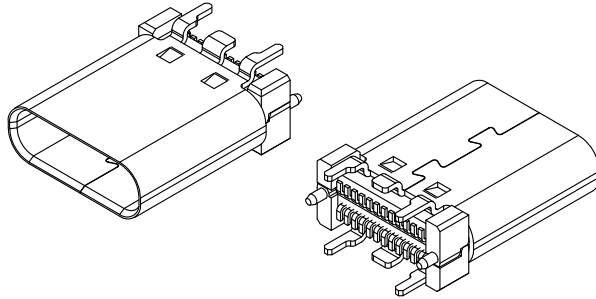

USB TYPE-C FULL-FEATURED RECEPTACLE INTERFACE PIN ASSIGNMENTS

PIN	Signal Name	Description	PIN	Signal Name	Description
A1	GND	Ground return	B12	GND	Ground return
A2	SSTxp1	Positive half of first SuperSpeed TX differential pair	B11	SSRXp1	Positive half of first SuperSpeed RX differential pair
A3	SSTXn1	Negative half of first SuperSpeed TX differential pair	B10	SSRXn1	Negative half of first SuperSpeed RX differential pair
A4	Vbus	Bus Power	B9	Vbus	Bus Power
A5	CC1	Configuration Channel	B8	SBU2	Sideband Use (SBU)
A6	Dp1	Positive half of the USB 2.0 differential pair-Position 1	B7	Dn2	Negative half of the USB 2.0 differential pair-Position 2
A7	Dn1	Negative half of the USB 2.0 differential pair-Position 1	B6	Dp2	Positive half of the USB 2.0 differential pair-Position 2
A8	SBU1	Sideband Use(SBU)	B5	CC2	Configuraaion Channel
A9	Vbus	Bus Power	B4	Vbus	Bus Power
A10	SSRXn2	Negative half of second SuperSpeed RX differential pair	B3	SSTXn2	Negative half of second SuperSpeed TX differential pair
A11	SSRXp2	Positive half of second SuperSpeed RX differential pair	B2	SSTXp2	Positive half of second SuperSpeed TX differential pair
A12	GND	Ground return	B1	GND	Ground return

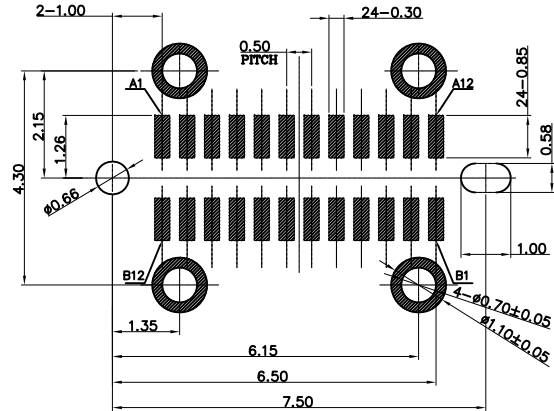

RECOMMENDED P.C.B. LAYOUT (T:1.00mm)
TOLERANCE UNSPECIFIED ±0.05mm

DO NOT SCALE DRAWING

DIMENSIONS: <input type="checkbox"/> MM [INCH] <input type="checkbox"/> INCH [mm] <input checked="" type="checkbox"/> MM ONLY		
UNLESS OTHERWISE SPECIFIED, GENERAL TOLERANCE: DECIMALS: X. ±0.38, .X ±0.25, .XX ±0.15 ANGLES: X° ±3°, .X° ±1.0°		
MATERIAL:		TITLE 184j SERIES USB 3.1 TYPE C
FINISH:		
CAD GENERATED DRAWING, DO NOT MANUALLY UPDATE DRAWN BY AND DATE: Xie 2017-12-15 CHECKED BY AND DATE: Fan 2017-12-15 APPROVED BY AND DATE: Zhou 2017-12-15 THIRD ANGLE PROJECTION		DRAWING NO. 184j-2440118 REV. A
SCALE: 1:1		FILE NO.: SHEET 2 OF 4